

Panasonic

900MHz Cordless Phone

Model No. **KX-TC1430W**

Pulse-or-tone dialing capability

Operating Instructions



Contents by Section

- 1 Getting Started
- 2 Making/Answering Calls
- 3 Special Features
- 4 Things You Should Know
- 5 Referencia rápida

**PLEASE READ BEFORE USE
AND SAVE.**

Charge the battery for about
4 hours before initial use.

Attach your purchase receipt here.

For your future reference

Serial No. _____

Date of purchase _____

(found on the bottom of the unit)

Name and address of dealer _____

For product service

- Panasonic Servicenters are listed in the servicenter directory.
- Call 1-800-211-PANA(7262) for the location of an authorized servicenter.

When you ship the product

- Carefully pack your unit, preferably in the original carton.
- Attach a letter, detailing the symptom, to the outside of the carton.

Symptom _____

- Send the unit to an authorized servicenter, prepaid and adequately insured.
- Do not send your unit to the Panasonic Consumer Electronics Company listed below or to executive or regional sales offices. These locations do not repair consumer products.

**Panasonic Consumer Electronics Company,
Division of Matsushita Electric Corporation of America**
One Panasonic Way, Secaucus, New Jersey 07094

**Panasonic Sales Company,
Division of Matsushita Electric of Puerto Rico, Inc.**
Ave. 65 de Infantería, Km. 9.5, San Gabriel Industrial Park
Carolina, Puerto Rico 00985

1-A Accessories

- AC Adaptorone
Order No. KX-TCA1-G

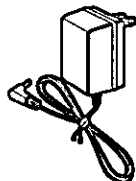

- Telephone Line Cord
.....one

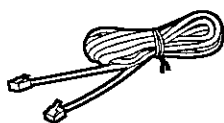

- For extra orders, call
1-800-332-5368.

1-B Location of Controls

Handset

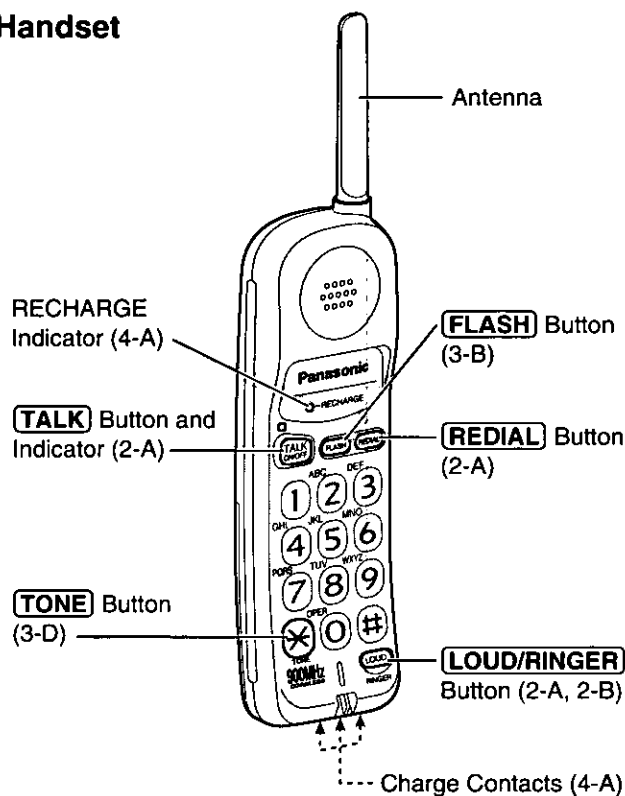

Base unit

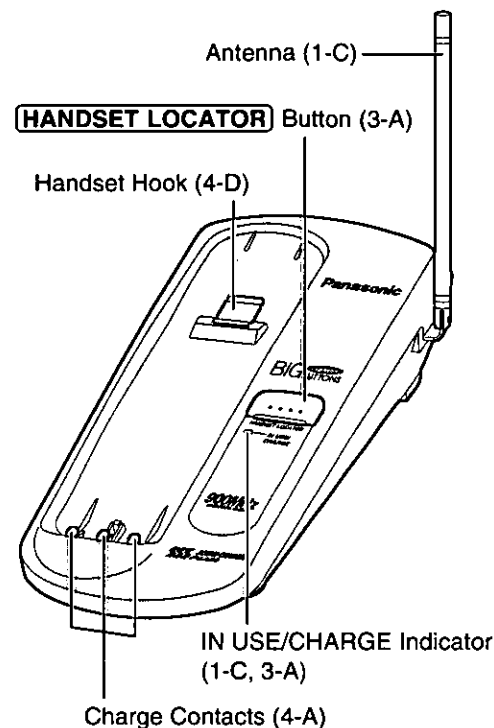

1-C Settings

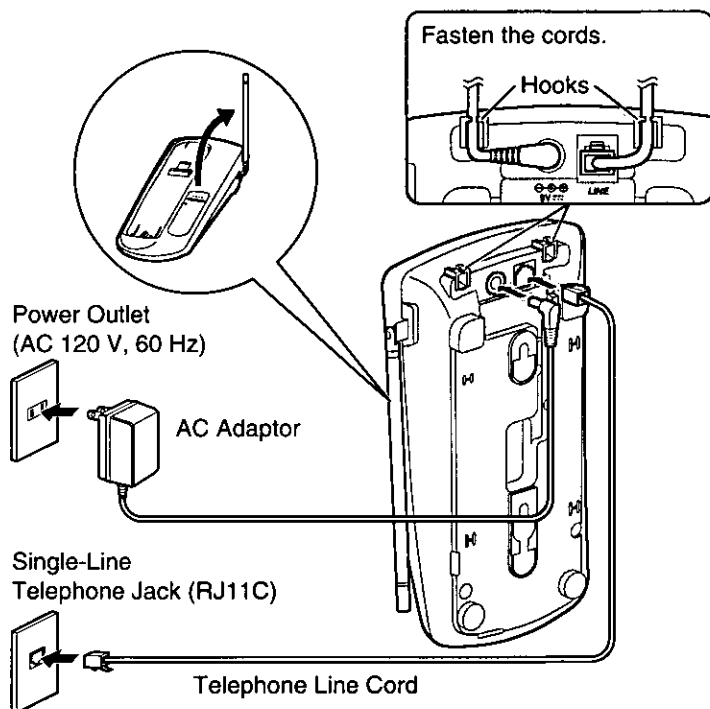

- USE ONLY WITH Panasonic AC ADAPTOR KX-TCA1 (Order No. KX-TCA1-G).
- The AC adaptor must remain connected at all times. (It is normal for the adaptor to feel warm during use.)
- To connect a standard telephone on the same line, see section 4-F.

1 Connect as shown.

2 Raise the antenna.



3 Charge the battery for about 4 hours.

- See section 4-A for more details.
- The IN USE/CHARGE indicator lights.

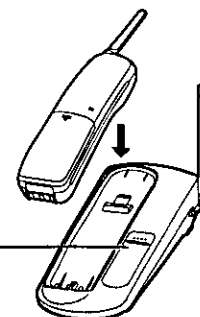

To select the dialing mode TONE (preset) or PULSE

You can program the dialing mode using the handset near the base unit. The TALK indicator light must be off before programming.

Press **#** (PULSE) until 2 beeps sound.

While pressing **FLASH** → **OR**

Press ***** (TONE) until 2 beeps sound.

- If a power failure occurs, the mode will return to the factory preset (TONE). Reprogram if necessary.

2-A Making Calls

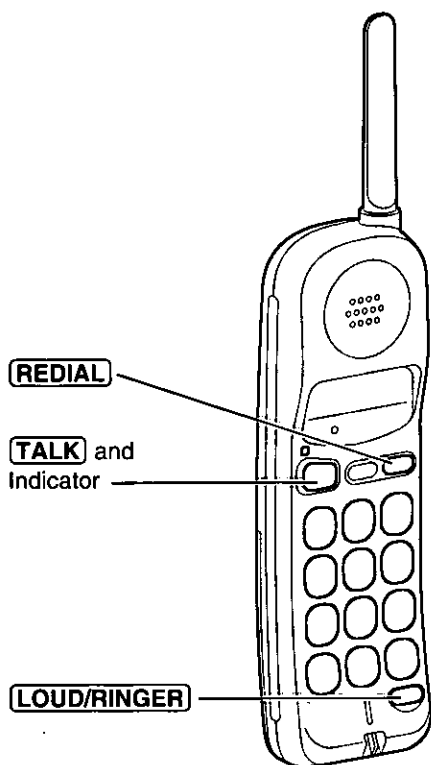

- 1 Press **TALK**.
 - The TALK indicator lights.
 - If an alarm tone sounds, see 4-E.
- 2 Dial a telephone number.
- 3 To hang up, press **TALK** or place the handset on the base unit.
 - The indicator light goes out.

OPERATING DISTANCE

For best operating performance, see section 4-C.

To redial the last number dialed

Press **TALK** ➔ **REDIAL**.

To select the receiver volume

Press **LOUD/RINGER** while talking.

- Each time you press the button, the volume level will change from MEDIUM (preset) to HIGH to LOW.

Lighted handset keypad

The handset dialing buttons will light when you press a button or lift the handset off the base unit, and flash when a call is received. The lights will go out about 10 seconds after pressing a button, lifting the handset or answering a call.

2-B Answering Calls

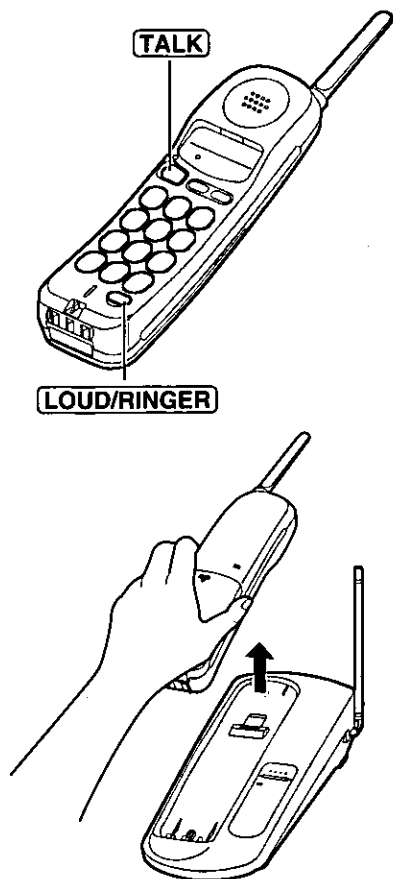

If the handset is off the base unit, press **TALK**.

- You can also answer a call by pressing any dialing button **0** to **9**, ***** or **#** (- Any Key Talk).

OR

If on the base unit, just lift up.

Selecting the ringer volume

The TALK indicator light must be off.

- To select **HIGH (preset)** or **LOW**, press **LOUD/RINGER**. (Each time you press the button, the ringer volume will change and the selected volume will ring.)
- To turn the ringer **OFF**, press and hold **LOUD/RINGER** until 2 beeps sound.
- To turn the ringer **ON**, press **LOUD/RINGER**. The ringer will sound at the HIGH level.

3 Special Features

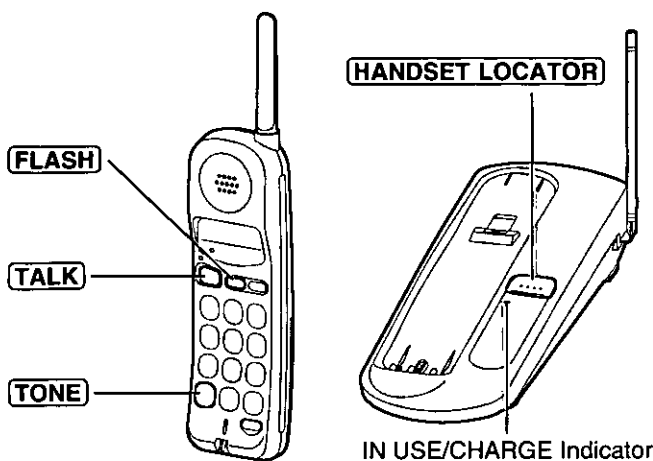

3-A Handset Locator

You can locate the handset or page the handset user with beep tones.

- 1 Press **HANDSET LOCATOR** on the base unit.
 - The IN USE/CHARGE indicator flashes and the handset beeps for 1 minute.
- 2 To stop paging, press **HANDSET LOCATOR** again or press **TALK** twice on the handset.

3-B For Call Waiting Service Users

Press **FLASH** if you hear a call-waiting tone while talking.

- The first call is put on hold and you can answer the second call.
- To return to the first caller, press **FLASH** again.

3-C Automatic Security Code Setting

Whenever you place the handset on the base unit, the unit automatically selects one of a million security codes. These codes help prevent the unauthorized use of your telephone line by another cordless telephone user.

3-D Temporary Tone Dialing (For Rotary or Pulse Service Users)

Press **TONE** before entering access numbers which require tone dialing.

- The dialing mode changes to tone. You can enter numbers to access an answering service, electronic banking service, etc. When you hang up, the mode will return to pulse.
- Access numbers entered after pressing **TONE** will not be included when redialing.



4-A Battery

Recharge

When the RECHARGE indicator flashes, or the unit beeps intermittently, place the handset on the base unit for about 4 hours to recharge the battery.

- If you DO NOT recharge the handset battery for more than 15 minutes, the RECHARGE indicator will continue to flash.

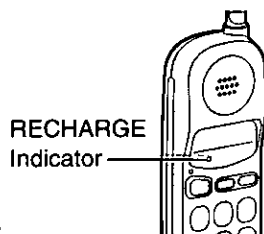

Battery information

After your Panasonic battery is fully charged:

Operation	Approx. battery life
While in use (TALK)	Up to about 8 hours
While not in use (Stand-By)	Up to about 21 days

- Battery life may vary depending on usage conditions and ambient temperature.
- The battery cannot be overcharged.
- **Clean the handset and the base unit charge contacts with a soft, dry cloth once a month. Clean more often if the unit is subject to grease, dust or high humidity.** Otherwise the battery may not charge properly.
- If the battery is fully charged, you do not have to place the handset on the base unit until the RECHARGE indicator flashes. This will maximize the battery life.

4-C Base Unit Location

Calls are transmitted between the base unit and the handset using wireless radio waves. **For maximum distance and noise free operation**, the recommended base unit location is:

Away from electrical appliances such as a TV, radio or personal computer.

In a HIGH and CENTRAL location with no obstructions such as walls.

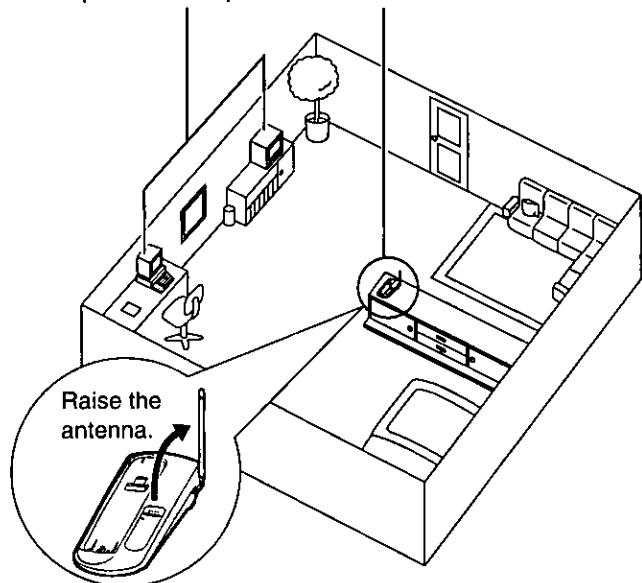

4-B Battery Replacement

If the RECHARGE indicator flashes after being fully charged, replace the battery with a new Panasonic P-P501 (KX-A36) battery. To order, call the accessories telephone number in section 1-A. To prevent loss of memory replace within 3 minutes.

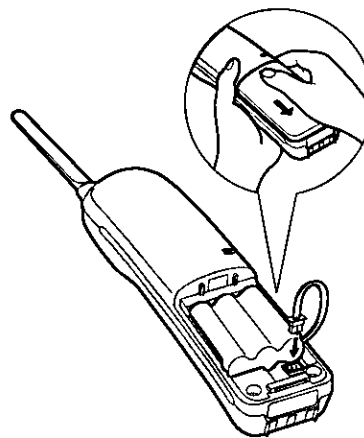

- 1 Remove the cover by sliding while pressing the arrow.
- 2 Replace the battery, and close the cover.
- 3 Be sure to charge the new battery for about 4 hours.

Attention:

The product you have purchased is powered by a nickel cadmium battery which is recyclable. At the end of its useful life, under various state and local laws, it is illegal to dispose of this battery into your municipal waste stream. Please call 1-800-8-BATTERY for information on how to recycle this battery.



4-D Wall Mounting

This unit can be mounted on a wall phone plate.

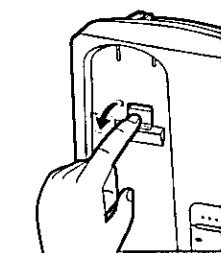

- 1 Pull down the handset hook until it locks, so the tab holds the handset.

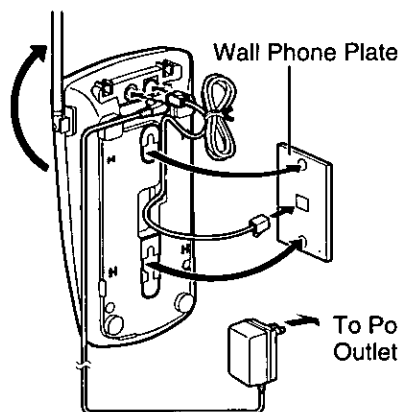

- 2 Connect the AC adaptor and telephone line cord.
- 3 Mount the unit, then slide down.
 - Raise the antenna.



4-E Before Requesting Help

Problem	Remedy
The unit does not work.	<ul style="list-style-type: none"> • Check the settings (1-C). • Charge the battery fully (4-A). • Clean the charge contacts and charge again (4-A). • Install the battery properly (4-B). • Place the handset on the base unit and unplug the AC adaptor to reset. Plug in and try again. • Re-insert the handset battery within 3 minutes to avoid loss of memory and place the handset on the base unit. Try again.
An alarm tone sounds when you press TALK .	<ul style="list-style-type: none"> • You are too far from the base unit. Move closer and try again. • Place the handset on the base unit and try again. • Plug in the AC adaptor. • Raise the base unit antenna.
Static, sound cuts in/out, fades. Interference from other electrical units.	<ul style="list-style-type: none"> • Locate the handset and the base unit away from other electrical appliances (4-C). • Move closer to the base unit. • Raise the base unit antenna.
The unit does not ring.	<ul style="list-style-type: none"> • The ringer volume is set to OFF. Press LOUD/RINGER while the TALK indicator light is off (2-B).

Problem	Remedy
You cannot redial by pressing REDIAL .	<ul style="list-style-type: none"> • Access numbers entered after pressing TONE will not be included when redialing (3-D). • If the last number dialed was more than 32 digits long, the number will not be redialed.
HANDSET LOCATOR does not function.	<ul style="list-style-type: none"> • The handset is too far from the base unit or is engaged in an outside call.
The RECHARGE indicator flashes or the unit beeps intermittently.	<ul style="list-style-type: none"> • Charge the battery fully (4-A).
You charged the battery fully, but the RECHARGE indicator flashes.	<ul style="list-style-type: none"> • Clean the charge contacts and charge again (4-A). • Install a new battery (4-B).
The IN USE/CHARGE indicator light does not go out while charging.	<ul style="list-style-type: none"> • This is normal.
If you cannot solve your problem	<ul style="list-style-type: none"> • Call our customer call center at 1-800-211-PANA(7262).

4-F Adding Another Phone

This unit will not function during a power failure. To connect a standard telephone on the same line, use the Panasonic T-adaptor KX-J66. To order, call the accessories telephone number in section 1-A.

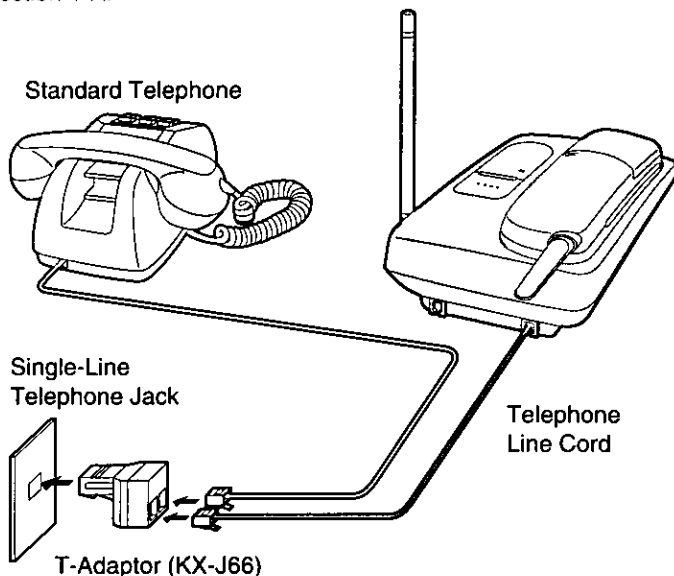

4-G Helpful Information

- **Environment**—do not place the unit in a room where the temperature is less than 5°C (41°F) or greater than 40°C (104°F). Allow 10 cm (4") clearance around the unit for proper ventilation. Avoid excessive smoke, dust, mechanical vibration, shock, or direct sunlight.
- **Routine care**—wipe the unit with a soft cloth. Do not use benzine, thinner, or any abrasive powder. When you leave the unit unused for a long period of time, unplug the AC adaptor from the outlet.
- **If there is any trouble**—disconnect the unit from the telephone line and connect a known working phone. If the known working phone operates properly, have your unit repaired by one of the authorized Panasonic Factory Service Centers. If the known working phone does not operate properly, consult your telephone company.

- This cordless telephone is designed for use in the United States of America. Sale or use of this product in other countries may violate local laws.
- Ce téléphone sans fil est conçu pour être utilisé aux États-Unis d'Amérique. La vente ou l'emploi de cet appareil dans certains autres pays peut constituer une infraction à la législation locale.
- Este teléfono sin cordón fue elaborado para uso en los Estados Unidos de América. La venta o el empleo de este producto en ciertos países puede constituir violación de la legislación local.
- このコードレス電話機は、日本国外での使用を目的として設計されており、日本国内での使用は法律違反となります。従って、当社では日本国内においては原則として修理などのサービスは致しかねます。

4-H Important Safety Instructions

When using this unit, basic safety precautions should always be followed to reduce the risk of fire, electric shock, or personal injury.

1. Read and understand all instructions.
2. Follow all warnings and instructions marked on this unit.
3. Unplug this unit from AC outlets before cleaning. Do not use liquid or aerosol cleaners. Use a damp cloth for cleaning.
4. Do not use this unit near water, for example, near a bathtub, washbowl, kitchen sink, or the like.
5. Place this unit securely on a stable surface. Serious damage and/or injury may result if the unit falls.
6. Do not cover slots and openings on the unit. They are provided for ventilation and protection against overheating. Never place the unit near radiators, or in a place where proper ventilation is not provided.
7. Use only the power source marked on the unit. If you are not sure of the type of power supplied to your home, consult your dealer or local power company.
8. Do not place objects on the power cord. Install the unit where no one can step or trip on the cord.
9. Do not overload wall outlets and extension cords. This can result in the risk of fire or electric shock.
10. Never push any objects through slots in this unit. This may result in the risk of fire or electric shock. Never spill any liquid on the unit.
11. To reduce the risk of electric shock, do not disassemble this unit. Take the unit to an authorized servicenter when service is required. Opening or removing covers may expose you to dangerous voltages or other risks. Incorrect reassembly can cause electric shock when the unit is subsequently used.

12. Unplug this unit from the wall outlet and refer servicing to an authorized servicenter when the following conditions occur:
 - A. When the power supply cord or plug is damaged or frayed.
 - B. If liquid has been spilled into the unit.
 - C. If the unit has been exposed to rain or water.
 - D. If the unit does not work normally by following the operating instructions. Adjust only controls covered by the operating instructions. Improper adjustment may require extensive work by an authorized servicenter.
 - E. If the unit has been dropped or physically damaged.
 - F. If the unit exhibits a distinct change in performance.
13. During thunderstorms, avoid using telephones except cordless types. There may be a remote risk of an electric shock from lightning.
14. Do not use this unit to report a gas leak, when in the vicinity of the leak.

CAUTION:

To reduce the risk of fire or injury to persons, read and follow these instructions.

1. Use only the battery(ies) specified.
2. Do not dispose of the battery(ies) in a fire. They may explode. Check with local waste management codes for special disposal instructions.
3. Do not open or mutilate the battery(ies). Released electrolyte is corrosive and may cause burns or injury to the eyes or skin. The electrolyte may be toxic if swallowed.
4. Exercise care in handling batteries in order not to short the battery to conductive materials such as rings, bracelets, and keys. The battery and/or conductor may overheat and cause burns.
5. Charge the battery(ies) provided with or identified for use with this product only in accordance with the instructions and limitations specified in this manual.

WARNING:

TO PREVENT FIRE OR SHOCK HAZARD, DO NOT EXPOSE THIS PRODUCT TO RAIN OR ANY TYPE OF MOISTURE.

SAVE THESE INSTRUCTIONS

4-I FCC Information

If requested by the telephone company, inform them as follows:
 FCC Registration No.(found on the bottom of the unit)
 Ringer Equivalence0.1B
 The particular telephone line to which the equipment is connected.

This unit must not be connected to a coin operated line.

If you are on a party line, check with your local telephone company.

Ringer Equivalence No. (REN):

The REN is useful in determining the quantity of devices you may connect to your telephone line and still have all of those devices ring when your telephone number is called. In most, but not all areas, the sum of the REN's of all devices connected to one line should not exceed five (5.0). To be certain of the number of devices you may connect to your line, as determined by the REN, you should contact your local telephone company to determine the maximum REN for your calling area.

In the event terminal equipment causes harm to the telephone network, the telephone company should notify the customer, if possible, that service may be stopped.

However, where prior notice is impractical, the company may temporarily cease service providing that they:

- (a) Promptly notify the customer.
- (b) Give the customer an opportunity to correct the problem with their equipment.
- (c) Inform the customer of the right to bring a complaint to the Federal Communication Commission pursuant to procedures set out in FCC Rules and Regulations Subpart E of Part 68.

The Telephone Company may make changes in its communications facilities, equipment, operations or procedures, where such action is reasonably required in the operation of its business and is not inconsistent with the rules and regulations in FCC Part 68.

If such changes can be reasonably expected to render any customer terminal equipment incompatible with telephone company communications facilities, or require modification or alteration of such terminal equipment, or otherwise materially affect its use or performance, the customer shall be given adequate notice in writing, to allow the customer an opportunity to maintain uninterrupted service.

When programming emergency numbers and/or making test calls to emergency numbers:

1. Remain on the line and briefly explain to the dispatcher the reason for the call before hanging up.
2. Perform such activities in the off-peak hours, such as early morning hours or late evenings.

This device complies with Part 15 of the FCC Rules. Operation is subject to the following two conditions: (1) This device may not cause harmful interference, and (2) this device must accept any interference received, including interference that may cause undesired operation.

Privacy of communications may not be ensured when using this phone.

CAUTION:

Any changes or modifications not expressly approved by the party responsible for compliance could void the user's authority to operate this device.

Note:

This equipment has been tested and found to comply with the limits for a Class B digital device, pursuant to Part 15 of the FCC Rules. These limits are designed to provide reasonable protection against harmful interference in a residential installation. This equipment generates, uses, and can radiate radio frequency energy and, if not installed and used in accordance with the instructions, may cause harmful interference to radio communications. However, there is no guarantee that interference will not occur in a particular installation. If this equipment does cause harmful interference to radio or television reception, which can be determined by turning the equipment off and on, the user is encouraged to try to correct the interference by one or more of the following measures:

- Reorient or relocate the receiving antenna.
- Increase the separation between the equipment and receiver.
- Connect the equipment into an outlet on a circuit different from that to which the receiver is connected.
- Consult the dealer or an experienced radio/TV technician for help.

Some cordless telephones operate at frequencies that may cause interference to nearby TVs and VCRs. To minimize or prevent such interference, the base of the cordless telephone should not be placed near, or on top of, a TV or VCR. If interference is experienced, move the cordless telephone farther away from the TV or VCR. This will often reduce, or eliminate, interference.

5-A Preparación

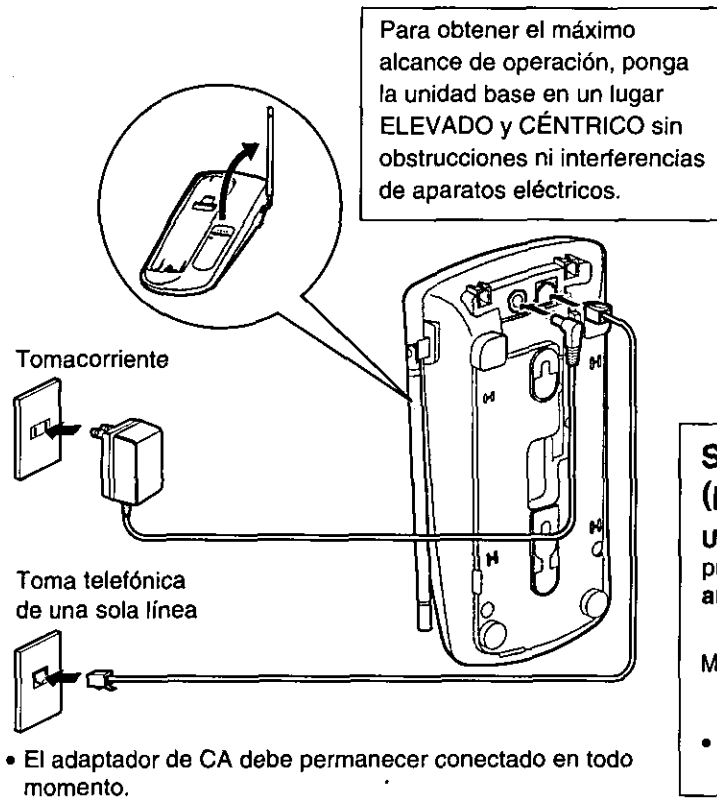

- 1 Conecte como se muestra.
- 2 Levante la antena.
- 3 Cargue la batería durante unas 4 horas.

- El indicador IN USE/CHARGE se encenderá.

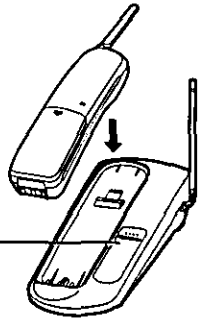

Selección del modo de marcación por TONO (preajustado) o PULSACIÓN

Utilizando la unidad portátil cerca de la unidad base usted puede programar el modo de marcación. El indicador TALK deberá estar apagado antes de programar.

- Presione **#** (PULSACIÓN) hasta que suenen 2 pitidos. Mientras presiona **FLASH** ➔ **O**
- Presione ***** (TONO) hasta que suenen 2 pitidos.
- Si se produce un corte de electricidad, el modo volverá al prefijado (TONO). Vuelva a programar si fuera necesario.

5-B Funcionamiento

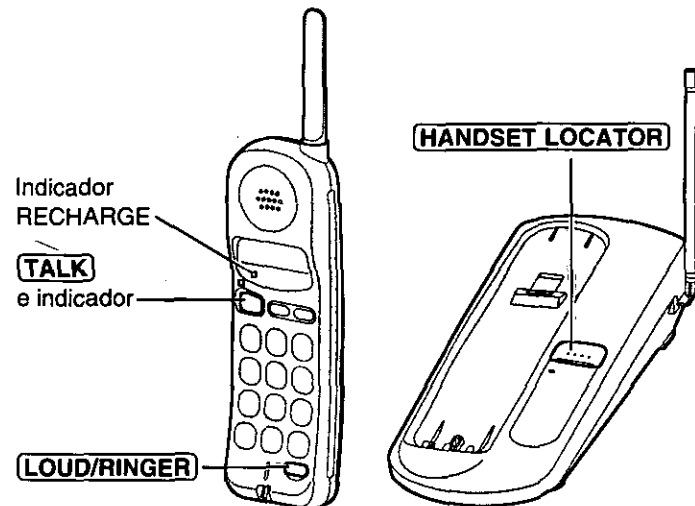

- Cuando el indicador RECHARGE parpadee o la unidad emita pitidos intermitentemente, cargue la batería.

Para hacer llamadas

Presione **TALK** ➔ Marque un número de teléfono. ➔ Cuando termine, presione **TALK** o ponga la unidad portátil en la unidad base.

Para seleccionar el volumen del receptor

Presione **LOUD/RINGER** mientras habla.

- Cada vez que presione el botón, el volumen cambiará de MEDIANO (prefijado) a ALTO a BAJO.

Contestación de llamadas

Si la unidad portátil no está en la unidad base, presione **TALK** o cualquier botón de marcación (**0** a **9**, ***** o **#**). Si está en la unidad base, levántela solamente.

Para seleccionar el volumen del timbre

El indicador TALK deberá estar apagado.

- Para seleccionar ALTO (prefijado) o BAJO, presione **LOUD/RINGER**. (Cada vez que Ud. presiona el botón, el volumen seleccionado sonará y el volumen del timbre cambiará.)
- Para apagar el timbre, mantenga presionado **LOUD/RINGER** hasta que suenen 2 pitidos.
- Para encender el timbre, presione **LOUD/RINGER**. El timbre sonará en el nivel ALTO.

Localización de la unidad portátil

Presione **HANDSET LOCATOR** en la unidad base.

- La unidad portátil emite pitidos durante 1 minuto.
- Para detener la localización, presione de nuevo **HANDSET LOCATOR** o presione dos veces **TALK** en la unidad portátil.